

233K/522PZ   
233K/523ZA

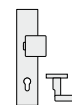

241K/522PZ   
241K/523ZA

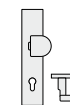

242K/522PZ   
242K/523ZA

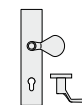

248K/522PZ   
248K/523ZA

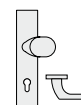

263/522PZ   
263/523ZA

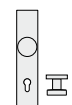

280/522PZ   
280/523ZA

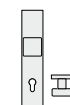

283/522PZ   
283/523ZA

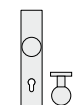

285/522PZ   
285/523ZA

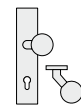

286/522PZ   
286/523ZA

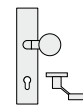

288/522PZ   
288/523ZA

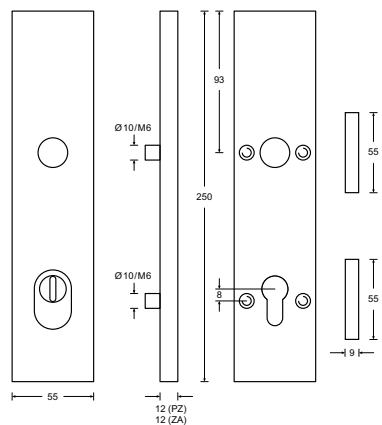

HAFI Schutzbeschlag – Design 522PZ/523ZA

Schutzgarnitur aus massivem Edelstahl, mit Langschild außen und Rosetten innen, unsichtbare Befestigung, mit Knopf und Türdrücker

Schutzklasse SK3 (ES2)

Vierkantstift 8 mm, Vierkantstift 9 mm

PZ 92/72/55 (weitere Lochungen auf Anfrage)

1.000.000 Bewegungszyklen mit Zertifikat\*  
freies Spiel < 1,0 mm  
freie Winkelbewegung < 1,0 mm

Klassifizierungsschlüssel nach DIN EN 1906  
**4171-B153U**

- Edelstahl matt
- Edelstahl poliert

Alle verfügbaren Türdrückermodelle – siehe Seite 451