

**HAFI** 



# Living space

The World of Door Handles – Product Overview



---

# info

<b>About HAFI</b> Über HAFI	6
<b>Mix it!</b> Create your door handle	8
<b>Brilliant metal</b> PVD - Gems	10
<b>Safety first!</b> Safety certifications	12
<b>Flush Line</b> Flush-mounted aesthetics and reduced rosette design.	38
<b>Change it!</b> Push and Click	42

# classic

# exclusive

<b>Classic. Timeless. Distinct.</b>	<b>15</b>
Door handles	16
Lavatory rosettes	24
Window handles	25
Protective fittings	32
Lifting-sliding door handles	33
Door stops	34
Accessories	36

<b>Exclusive. Extraordinary. Elegant.</b>	<b>44</b>
Door handles	46
Window handles	58
Protective fittings	62
Lifting-sliding door handles	69

# About HAFI

**HAFI Beschläge GmbH – giving the best to our customers around the world since 1978.**

## **Since 1978**

Hans Fink founded HAFI in 1978, today the company is managed by René Fink and Jochen Maier. We develop and manufacture fittings for customers around the world from our location in Elchingen, Germany. Our employees share our passion and give their best to our customers every day. In 2018, HAFI manufactured 450,000 fitting pieces for doors and windows.

## **Fitting products – we shape fine steel**

HAFI produces a number of fitting products out of stainless steel. The shape and surface finish can be produced individually.

Whether matte-brushed or polished, stainless steel surfaces are durable, elegant and timeless. Thanks to the exceptionally smooth and non-porous surface, stainless steel handles are very dirt-resistant and long-lasting.

## **Customised to meet the customer's wishes**

We turn our customer's ideas into reality, and accompany you from concept creation and prototype construction to multi-trade delivery of the item. Thanks to the PVD coating, we can produce fittings in various colours and surface finishes.

## **Multi-trade**

We have the right solution for any building type and any requirement. For door handles for residential building to electronic locking systems in public buildings.

## **Easy installation**

Our fittings prove that design and technology can go hand in hand. One example is our latest development – Flush Line technology for windows, doors and lifting-sliding doors.





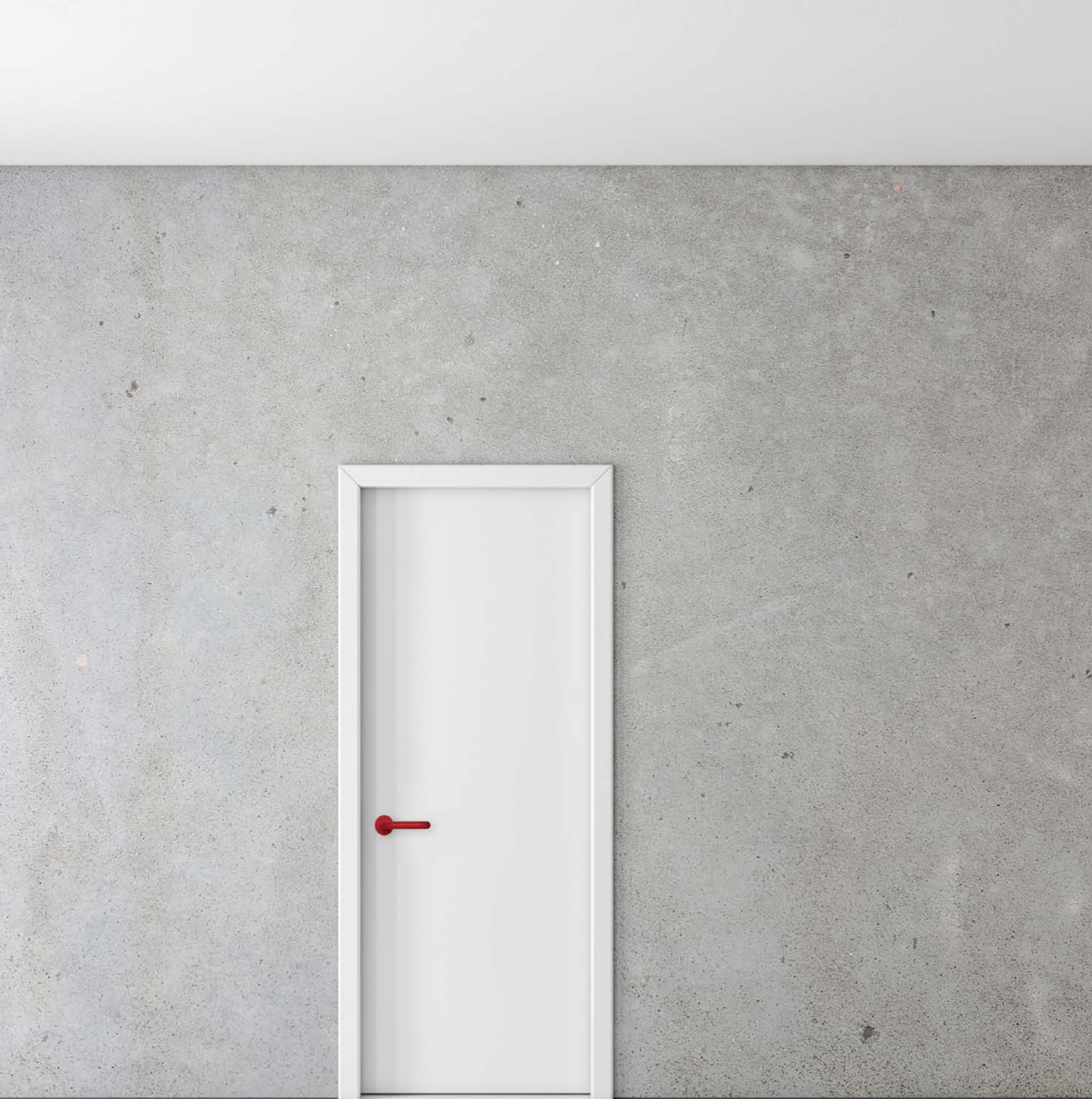

# Mix it!

Create your door handle.

## 1. Select your handle rosette.



Round 1-piece



Round 2-piece



Square 1-piece



Square 2-piece

## 2. Select the keyhole rosette.



Profile cylinder round



Round cylinder round



Euro round



Warded lock round



Profile cylinder square



Round cylinder square



Euro square



Warded lock square

## 3. Select your surface.

### PVD - create highlights with metallic colours!

Rosé-gold, bronze, brass or black - create highlights with PVD-coated fittings. In addition to brilliant colour intensity, the PVD-coating also shines with excellent resistance to scratches and wear.

The PVD surfaces are available in a matte and polished version.



Black



Bronze



Rosé-gold













Brass



# Brilliant metal

Turn your fittings into gems with PVD-coating.

Rosé-gold, bronze, brass or black – create highlights with PVD-refined fittings. In addition to brilliant colour intensity, the PVD-coating also shines with excellent resistance to scratches and wear. These fittings are guaranteed to turn heads!

-  Stainless steel polished
-  Stainless steel matte
-  Brass polished
-  Brass matte
-  Rosé-gold polished
-  Rosé-gold matte
-  Dark-bronze polished
-  Dark-bronze matte
-  Black polished
-  Black matte

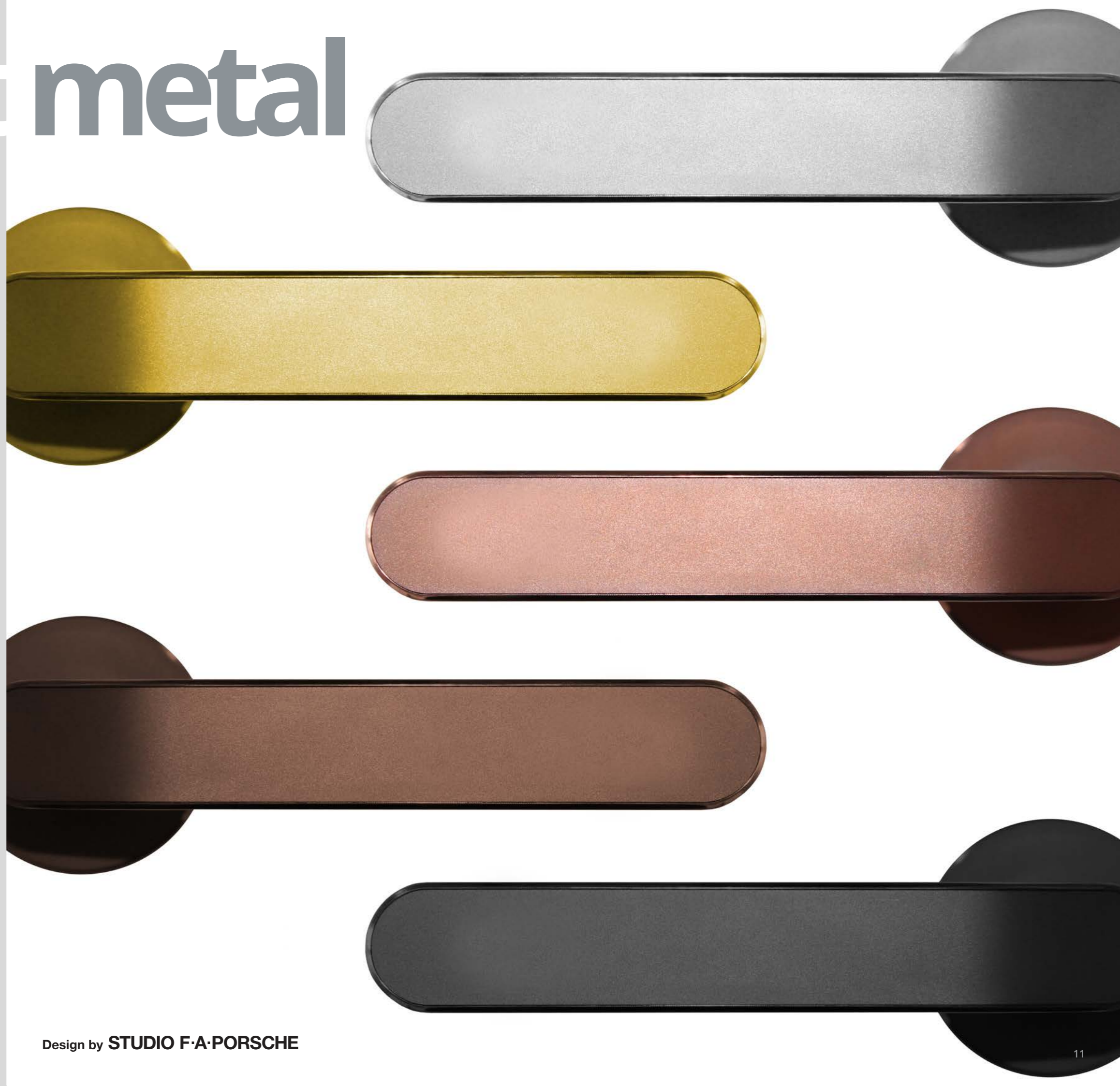

Design by **STUDIO F·A·PORSCHE**

# Safety first!

HAFI protective fittings – Tested. Certified. Safe.

## Break-in security



Protective fittings should effectively hinder forcible turning of the profile cylinder and a mechanical attack on the lock.

HAFI protective fittings are recommended by the Bavarian Criminal Police Bureau, and are documented in the list of “protective fittings inspected and certified to DIN 18257”.

Protective fittings certified to DIN 18257 are classified in the resistance classes ES 0 to ES 3, and/or certified to DIN EN 1906 (SK1 to SK4). Protective fittings from resistance class ES 1 and up are recommended.

## Fire protection



Fire protection fittings certified to DIN 18273 are components of the state building codes and/or Model Administrative Provisions - Technical Building Rules (MVVTB) and require a mark of conformity (ÜZ) as a usage certificate.

In accordance with this legal guideline, HAFI fire protection fittings are quality-monitored and have a mark of conformity issued by the material testing agency NRW.

## Emergency exit



Panic fitting combinations certified to Norm DIN EN 179 are utilised for emergency exits, where panic situations can be reckoned with.

HAFI offers you a wide, extensive and multi-trade assortment with corresponding testing and certifications for the combination of approved fitting packages certified to Norm DIN EN 179.





# classic

## Door handles



201 / 834



202 / 834



203 / 834



203 Q / 844



207 / 834



207 Q / 844



209 / 834



232 Q / 844

## Protective fittings



540 PZ / 263 / 201



540 PZ / 263 / 202



540 PZ / 263 / 203



540 PZ / 263 / 207



540 PZ / 263 / 209



490 PZ



491 ZA

## Lavatory rosettes



833 / 837



894 / 837



843 / 846

## Window handles



201 / 432



202 / 432



203 / 432



209 / 432

## Lifting-sliding door handles



202XXL / 450



203XXL / 450



224XXL / 450

## Door stops



982



984



985



987



975-978

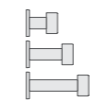

956-958

## Accessories



8990



899W



8753



8763





**Design 201 - HAFI Living Space**

HAFI Living Space stainless steel handle fittings swivel-mounted as a rosette fitting with steel slide bearing and spring support. Base structure made from galvanised steel, continuous screwing with firmly pressed threaded cam and through cam, invisible mounting.

tested to DIN EN 1906 User Category Class 3

Classification key 37-0140A

Door thickness 37 - 52 mm

Stainless steel matte  Stainless steel polished

PZ RZ Euro BB

**Door handle fittings**

Illustration	Model	round rosette		Fire protection <sup>EN</sup>
		1-piece	2-piece	
	201 / 834 / 835	•	-	•

**Knob-handle fittings**

Illustration	Model	round rosette		Fire protection <sup>EN</sup>
		1-piece	2-piece	
	201 / 280 / 834	•	-	•
	201 / 285 / 834	•	-	•
	201 / 288 / 834	•	-	•

**Bathroom fittings**

Illustration	Model	round rosette		Fire protection <sup>EN</sup>
		1-piece	2-piece	
	201 / 834 / 836 / 837	•	-	-



**Design 202 - HAFI Living Space**

HAFI Living Space stainless steel handle fittings swivel-mounted as a rosette fitting with steel slide bearing and spring support. Base structure made from galvanised steel, continuous screwing with firmly pressed threaded cam and through cam, invisible mounting.

tested to DIN EN 1906 User Category Class 3

Classification key 37-0140A

Door thickness 37 - 52 mm

Stainless steel matte  Stainless steel polished

PZ RZ Euro BB

**Door handle fittings**

Illustration	Model	round rosette		Fire protection <sup>EN</sup>
		1-piece	2-piece	
	202 / 834 / 835	•	-	•

**Knob-handle fittings**

Illustration	Model	round rosette		Fire protection <sup>EN</sup>
		1-piece	2-piece	
	202 / 280 / 834	•	-	•
	202 / 285 / 834	•	-	•
	202 / 288 / 834	•	-	•

**Bathroom fittings**

Illustration	Model	round rosette		Fire protection <sup>EN</sup>
		1-piece	2-piece	
	202 / 834 / 836 / 837	•	-	-





**Design 203 – HAFI Living Space**

HAFI Living Space stainless steel handle fittings swivel-mounted as a rosette fitting with steel slide bearing and spring support. Base structure made from galvanised steel, continuous screwing with firmly pressed threaded cam and through cam, invisible mounting.

tested to DIN EN 1906 User Category Class 3

Classification key 37-0140A

Door thickness 37 - 52 mm

Stainless steel matte 
  Stainless steel polished

PZ 
 RZ 
 Euro 
 BB

**Door handle fittings**

Illustration	Model	round rosette		Fire protection
		1-piece	2-piece	
	203 / 834 / 835	•	•	•

**Knob-handle fittings**

Illustration	Model	round rosette		Fire protection
		1-piece	2-piece	
	203 / 280 / 834	•	•	•
	203 / 285 / 834	•	•	•
	203 / 288 / 834	•	•	•

**Bathroom fittings**

Illustration	Model	round rosette		Fire protection
		1-piece	2-piece	
	203 / 834 / 836 / 837	•	•	-



**Design 203 Q – HAFI Living Space**

HAFI Living Space stainless steel handle fittings swivel-mounted as a rosette fitting with steel slide bearing and spring support. Base structure made from galvanised steel, continuous screwing with firmly pressed threaded cam and through cam, invisible mounting.

tested to DIN EN 1906 User Category Class 3

Classification key 37-0140A

Door thickness 37 - 52 mm

Stainless steel matte 
  Stainless steel polished

PZ 
 RZ 
 Euro 
 BB

**Door handle fittings**

Illustration	Model	square rosette		Fire protection
		1-piece	2-piece	
	203 Q / 844 / 845	•	•	•

**Knob-handle fittings**

Illustration	Model	square rosette		Fire protection
		1-piece	2-piece	
	203 Q / 283 / 844	•	•	•
	203 Q / 288 / 844	•	•	•

**Bathroom fittings**

Illustration	Model	square rosette		Fire protection
		1-piece	2-piece	
	203 Q / 844 / 846 / 847	•	•	-





**Design 207 - HAFI Living Space**

HAFI Living Space stainless steel handle fittings swivel-mounted as a rosette fitting with steel slide bearing and spring support. Base structure made from galvanised steel, continuous screwing with firmly pressed threaded cam and through cam, invisible mounting.

tested to DIN EN 1906 User Category Class 3

Classification key **37-0140A**

Door thickness 37 - 52 mm

■ Stainless steel matte ■ Stainless steel polished

PZ RZ Euro BB

**Door handle fittings**

Illustration	Model	round rosette		Fire protection
		1-piece	2-piece	
	207 / 834 / 835	•	•	•

**Knob-handle fittings**

Illustration	Model	round rosette		Fire protection
		1-piece	2-piece	
	207 / 280 / 834	•	•	•
	207 / 285 / 834	•	•	•
	207 / 288 / 834	•	•	•

**Bathroom fittings**

Illustration	Model	round rosette		Fire protection
		1-piece	2-piece	
	207 / 834 / 836 / 837	•	•	-



**Design 207 Q - HAFI Living Space**

HAFI Living Space stainless steel handle fittings swivel-mounted as a rosette fitting with steel slide bearing and spring support. Base structure made from galvanised steel, continuous screwing with firmly pressed threaded cam and through cam, invisible mounting.

tested to DIN EN 1906 User Category Class 3

Classification key **37-0140A**

Door thickness 37 - 52 mm

■ Stainless steel matte ■ Stainless steel polished

PZ RZ Euro BB

**Door handle fittings**

Illustration	Model	square rosette		Fire protection
		1-piece	2-piece	
	207 Q / 844 / 845	•	•	•

**Knob-handle fittings**

Illustration	Model	square rosette		Fire protection
		1-piece	2-piece	
	207 Q / 283 / 844	•	•	•
	207 Q / 288 / 844	•	•	•

**Bathroom fittings**

Illustration	Model	square rosette		Fire protection
		1-piece	2-piece	
	207 Q / 844 / 846 / 847	•	•	-







**Design 209 - HAFI Living Space**

HAFI Living Space stainless steel handle fittings swivel-mounted as a rosette fitting with steel slide bearing and spring support. Base structure made from galvanised steel, continuous screwing with firmly pressed threaded cam and through cam, invisible mounting.

tested to DIN EN 1906 User Category Class 3

Classification key 37-0140A

Door thickness 37 - 52 mm

Stainless steel matte  Stainless steel polished

PZ RZ Euro BB

**Door handle fittings**

Illustration	Model	round rosette		Fire protection
		1-piece	2-piece	
	209 / 834 / 835	•	-	•

**Knob-handle fittings**

Illustration	Model	round rosette		Fire protection
		1-piece	2-piece	
	209 / 280 / 834	•	-	•
	209 / 285 / 834	•	-	•
	209 / 288 / 834	•	-	•

**Bathroom fittings**

Illustration	Model	round rosette		Fire protection
		1-piece	2-piece	
	209 / 834 / 836 / 837	•	-	-



**Design 232 Q - HAFI Living Space**

HAFI Living Space stainless steel handle fittings swivel-mounted as a rosette fitting with steel slide bearing and spring support. Base structure made from galvanised steel, continuous screwing with firmly pressed threaded cam and through cam, invisible mounting.

tested to DIN EN 1906 User Category Class 3

Classification key 37-0140A

Door thickness 37 - 52 mm

Stainless steel matte  Stainless steel polished

PZ RZ Euro BB

**Door handle fittings**

Illustration	Model	square rosette		Fire protection
		1-piece	2-piece	
	232 Q / 844 / 845	-	•	-

**Knob-handle fittings**

Illustration	Model	square rosette		Fire protection
		1-piece	2-piece	
	232 Q / 283 / 844	-	•	-
	232 Q / 288 / 844	-	•	-

**Bathroom fittings**

Illustration	Model	square rosette		Fire protection
		1-piece	2-piece	
	232 Q / 844 / 846 / 847	-	•	-





**Design 837 / 836 HAFI Living Space**

Design lavatory rosettes, invisible mounting

with red /white display

- Stainless steel matte
- Stainless steel polished



**Design 894 / 836 HAFI Living Space**

Design lavatory rosettes, invisible mounting

with extra long latch

with red /white display

- Stainless steel matte
- Stainless steel polished



**Design 847 / 846 HAFI Living Space**

Design lavatory rosettes, invisible mounting

with red /white display

- Stainless steel matte
- Stainless steel polished



**Design 201 – HAFI Living Space**

Window handles with 90° locking mechanism, cam Ø 10 mm, mounting points 43 mm, square pin 7 mm (free pin length 24 | 30 | 32 | 35 mm).

- Stainless steel matte
- Stainless steel polished



**Design 202 – HAFI Living Space**

Window handles with 90° locking mechanism, cam Ø 10 mm, mounting points 43 mm, square pin 7 mm (free pin length 24 | 30 | 32 | 35 mm).

- Stainless steel matte
- Stainless steel polished



**Design 203 – HAFI Living Space**

Window handles with 90° locking mechanism, cam Ø 10 mm, mounting points 43 mm, square pin 7 mm (free pin length 24 | 30 | 32 | 35 mm).

- Stainless steel matte
- Stainless steel polished



**Design 209 – HAFI Living Space**

Window handles with 90° locking mechanism, cam Ø 10 mm, mounting points 43 mm, square pin 7 mm (free pin length 24 | 30 | 32 | 35 mm).

- Stainless steel matte
- Stainless steel polished



**Design 540 PZ | Handle 201 | Knob 263**



Protective fitting made from stainless steel, without spring system, invisible mounting, with knob and door handle.

Protection classes SK3 (ES2) and SK2 (ES1)

Square pin 8 mm, square pin 9 mm

PZ or ZA hole | 72 mm or 92 mm

■ Stainless steel matte ■ Stainless steel polished

**Door handle fittings**

Illustration	Model	Protection class 2	Protection class 3	Fire protection
	201 / 201 / 544 PZ	37-0152U	47-0153U	•
	201 / 201 / 545 ZA	37-0152U	47-0153U	•

**Knob-handle fittings**

Illustration	Model	Protection class 2	Protection class 3	Fire protection
	263 / 201 / 540 PZ	37-0152U	47-0153U	•
	263 / 201 / 541 ZA	37-0152U	47-0153U	•



**Design 540 PZ | Handle 202 | Knob 263**



Protective fitting made from stainless steel, without spring system, invisible mounting, with knob and door handle.

Protection classes SK3 (ES2) and SK2 (ES1)

Square pin 8 mm, square pin 9 mm

PZ or ZA hole | 72 mm or 92 mm

■ Stainless steel matte ■ Stainless steel polished

**Door handle fittings**

Illustration	Model	Protection class 2	Protection class 3	Fire protection
	202 / 202 / 544 PZ	37-0152U	47-0153U	•
	202 / 202 / 545 ZA	37-0152U	47-0153U	•

**Knob-handle fittings**

Illustration	Model	Protection class 2	Protection class 3	Fire protection
	263 / 202 / 540 PZ	37-0152U	47-0153U	•
	263 / 202 / 541 ZA	37-0152U	47-0153U	•





**Design 540 PZ | Handle 203 | Knob 263**



Protective fitting made from stainless steel, without spring system, invisible mounting, with knob and door handle.

Protection classes SK3 (ES2) and SK2 (ES1)

Square pin 8 mm, square pin 9 mm

PZ or ZA hole | 72 mm or 92 mm

■ Stainless steel matte ■ Stainless steel polished

**Door handle fittings**

Illustration	Model	Protection class 2	Protection class 3	Fire protection
	203 / 203 / 544 PZ	37-0152U	47-0153U	•
	203 / 203 / 545 ZA	37-0152U	47-0153U	•

**Knob-handle fittings**

Illustration	Model	Protection class 2	Protection class 3	Fire protection
	263 / 203 / 540 PZ	37-0152U	47-0153U	•
	263 / 203 / 541 ZA	37-0152U	47-0153U	•



**Design 540 PZ | Handle 207 | Knob 263**



Protective fitting made from stainless steel, without spring system, invisible mounting, with knob and door handle.

Protection classes SK3 (ES2) and SK2 (ES1)

Square pin 8 mm, square pin 9 mm

PZ or ZA hole | 72 mm or 92 mm

■ Stainless steel matte ■ Stainless steel polished

**Door handle fittings**

Illustration	Model	Protection class 2	Protection class 3	Fire protection
	207 / 207 / 544 PZ	37-0152U	47-0153U	•
	207 / 207 / 545 ZA	37-0152U	47-0153U	•

**Knob-handle fittings**

Illustration	Model	Protection class 2	Protection class 3	Fire protection
	263 / 207 / 540 PZ	37-0152U	47-0153U	•
	263 / 207 / 541 ZA	37-0152U	47-0153U	•



**Design 540 PZ | Handle 209 | Knob 263**



Protective fitting made from stainless steel, without spring system, invisible mounting, with knob and door handle.

Protection classes SK3 (ES2) and SK2 (ES1)

Square pin 8 mm, square pin 9 mm

PZ or ZA hole | 72 mm or 92 mm

■ Stainless steel matte ■ Stainless steel polished

**Door handle fittings**

Illustration	Model	Protection class 2	Protection class 3	Fire protection
	209 / 209 / 544 PZ	37-0152U	47-0153U	•
	209 / 209 / 545 ZA	37-0152U	47-0153U	•

**Knob-handle fittings**

Illustration	Model	Protection class 2	Protection class 3	Fire protection
	263 / 209 / 540 PZ	37-0152U	47-0153U	•
	263 / 209 / 541 ZA	37-0152U	47-0153U	•





**Design 490 / 499**



Protective rosettes without core pulling protection, solid interior rosette, concealed screws

Protection class SK2 (ES1)

PZ or RZ hole

■ Stainless steel matte

490 PZ



499 PZ



490 RZ



499 RZ

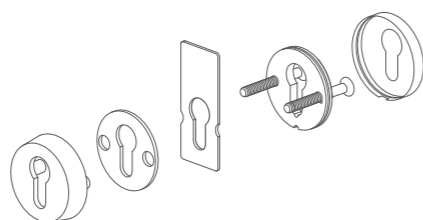

**Design 491 / 499**



Protective rosette with cylinder cover ZA (with core pulling protection), for cylinder protrusion 14 - 18 mm, solid interior rosette, concealed screws

Protection class SK2 (ES1)

■ Stainless steel matte

491



499 PZ

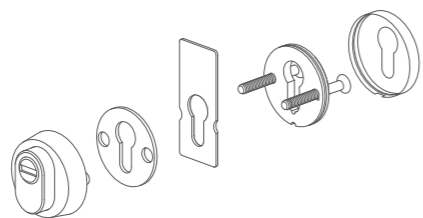

450



451

**Design 202XXL / 450 / 451**

Lifting-sliding door handles, with 180° or alternative 90° locking mechanism, swivel-mounted, square pin 10 mm, with or without through cam and/or threaded cam and M5 screws, invisible mounting.

■ Stainless steel matte ■ Stainless steel polished

PZ



RZ



Blank



450



451

**Design 203XXL / 450 / 451**

Lifting-sliding door handles, with 180° or alternative 90° locking mechanism, swivel-mounted, square pin 10 mm, with or without through cam and/or threaded cam and M5 screws, invisible mounting.

■ Stainless steel matte ■ Stainless steel polished

PZ



RZ



Blank



450



451

**Design 224XXL / 450 / 451**

Lifting-sliding door handles, with 180° or alternative 90° locking mechanism, swivel-mounted, square pin 10 mm, with or without through cam and/or threaded cam and M5 screws, invisible mounting.

■ Stainless steel matte ■ Stainless steel polished

PZ



RZ



Blank







**Design 982**

Ground door stop, including screws and dowels

matching shim for door stop available

■ Stainless steel matte



**Design 984**

Ground door stop, including screws and dowels

■ Stainless steel matte



**Design 985**

Ground door stop

including hanger bolt M10 x 80 mm  
and plastic dowel 12 x 60 mm

■ Stainless steel matte



**Design 987**

Ground and/or wall door stop, including screws and dowels

■ Stainless steel matte

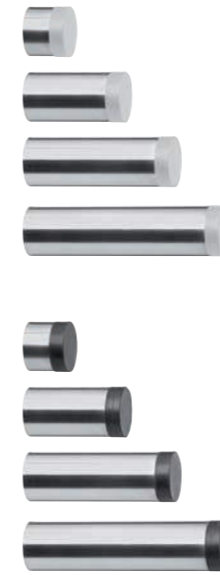

**Design 975 - 978**

Wall door stop with white or black rubber, including screws and dowels

■ Stainless steel matte

Design 975	L 26 mm
Design 976	L 60 mm
Design 977	L 90 mm
Design 978	L 120 mm



**Design 956 - 958**

Wall door stop with white or black rubber, including screws and dowels

Ø 30 mm or Ø 40 mm

■ Stainless steel matte

Design 956	L 60 mm
Design 957	L 90 mm
Design 958	L 120 mm



**HAFI Square pin 8990**

Square pin for knob-handle fittings

8 x	70 mm	9 x	70 mm
8 x	90 mm	9 x	90 mm
8 x	110 mm	9 x	110 mm
8 x	130 mm	9 x	130 mm
8 x	150 mm	9 x	150 mm



**HAFI Extension piece for handle fittings**

Extension piece for handle fittings differing from standard door thickness (37 - 50 mm)

Square pin 8 mm

Extension piece	
Set 1 (105464)	Door thickness 51 - 60 mm
Set 2 (105465)	Door thickness 61 - 70 mm
Set 3 (105466)	Door thickness 71 - 80 mm



**HAFI Square pin 899W**

Square pin offset for knob-handle fittings

8 / 8.5 x	70 mm
8 / 8.5 x	90 mm
8 / 10 x	110 mm



**HAFI Extension piece for knob-handle fittings**

Extension piece for knob-handle fittings differing from standard door thickness (37 - 50 mm)

Square pin 8 mm

Extension piece	
Set 1 (105467)	Door thickness 51 - 60 mm
Set 2 (105468)	Door thickness 61 - 70 mm
Set 3 (105469)	Door thickness 71 - 80 mm

# Flush Line

## HAFI Flush Line – Flush-mounted aesthetics and reduced rosette design.

We have adopted the design trend of reducing visible structures and have developed a new product line for door, window and lifting-sliding door handles.

The result is a combination of aesthetics, flush-mounted elements and winning easy installation.

The various surface variants in stainless steel that is polished, matte-brushed, or lacquered according to RAL request, enable the coverings of both window handles as well as lifting-sliding door handles to melt into one unit with the surface of the door element.

## Lifting-sliding door handles



## Door handles

With reduced design height of the rosette of just 4 mm with integrated spring function, the Flush Line technology enables unlimited usage for property or fire protection doors.

After the base structure has been attached in or on the door panel, the door handle can be mounted in seconds with the cover rosette with a simple “push-click” function and by tightening a grub screw.



## Window handles

The HAFI window handle is swivel-mounted on a base structure with ball catch with invisible grub screws.

The patented “push-push” function enables installation and disassembly of the cover without tools thanks to the easy latching of the rosette onto the base structure.

With flush-mounting the focus is shifted to the respective window handle design.



## Lifting-sliding door handles

For the first time, the patented “push-push” function allows a lifting-sliding door to be flush-mounted in aluminium or wood sliding doors in an easy-to-install way. Lacquered in the same colour, the cover and the frame melt into one.



# Minimalism

**in perfection.**

Clear and streamlined – in line with minimalism – introducing HAFI Flush Line technology. Lacquered in the same colour, the cover and the frame melt into one.





# Change it!

**With our "Push & Click" technology you can switch out door handles faster than ever before!**

This way any door handle can be switched at any time to match the interior design – in seconds. Once the base structure of the Flush Line has been mounted, handles can be attached as desired by pushing and clicking with "Push & Click".

The only tool that is needed is an Allen key, in order to tighten the clipped-on handle.

1. Choose the shape! Round or square?
2. Select your door handle model. Elegant, modern or timeless?
3. Select your surface.
4. Depending on the selected surface, you can select your customised colour choice!
5. Once our Flush Line base structure is mounted you can simply clip your new door handle on, tighten the grub screw & you're done!

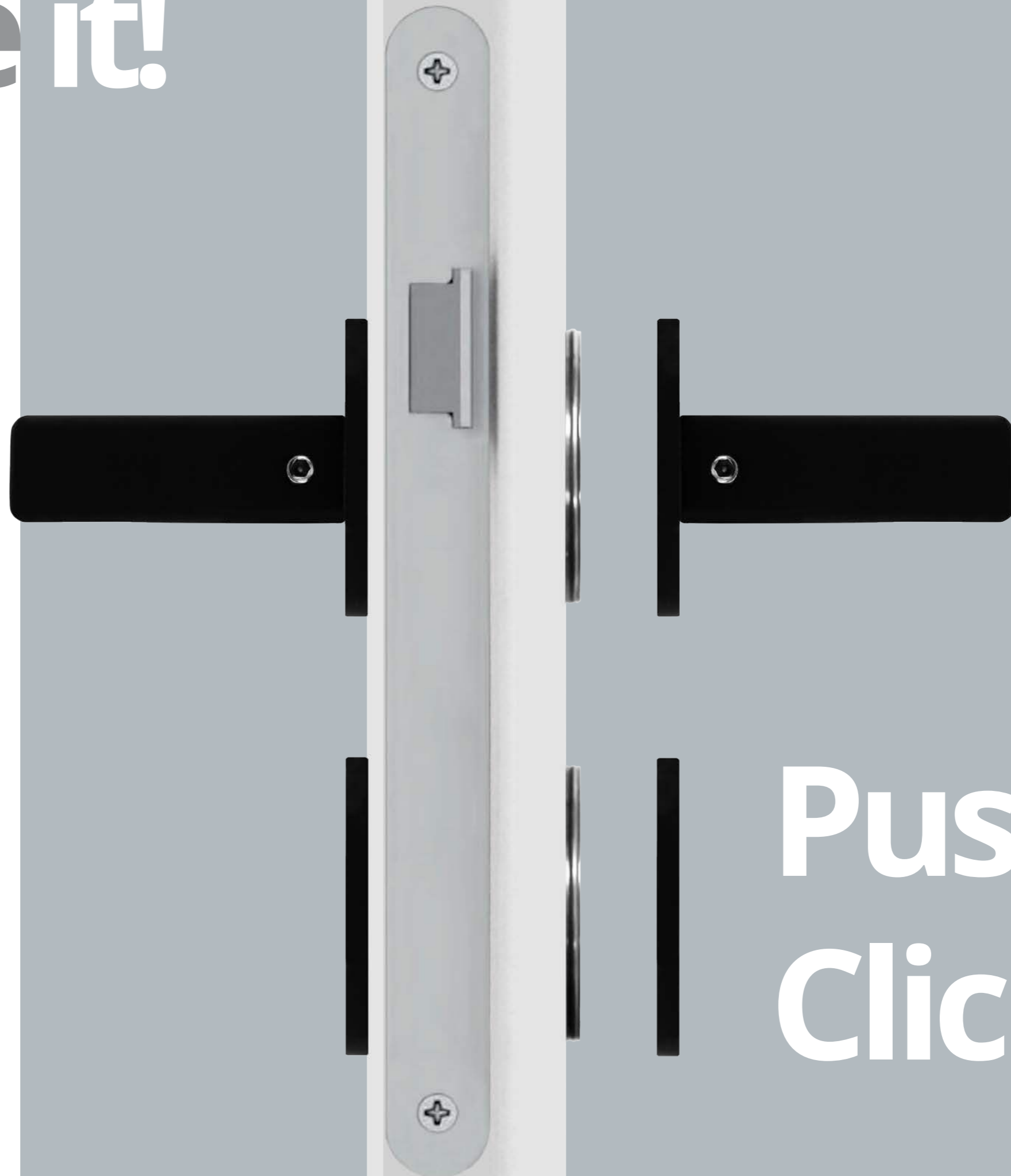
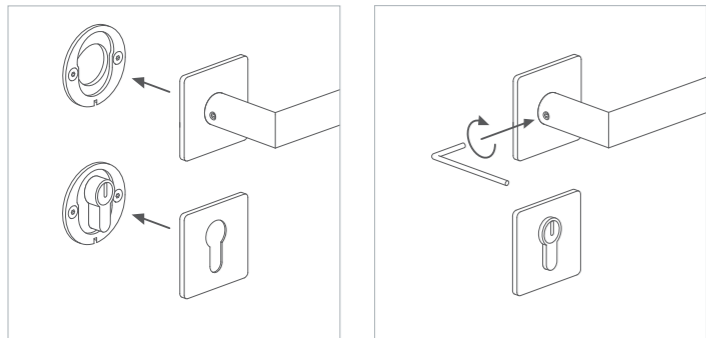

# Push & Click!

# exclusive

## Door handles



215 / 870



218L / 870



218L Q / 880



228 / 870



228 Q / 880



241 Q / 880



245 / 870



245 Q / 880



247 / 870



248 / 870



311 / 870



212 / 880

## Protective fittings



520 PZ / 245



521 ZA / 245



522 PZ / 245



523 ZA / 245



524 PZ / 245



525 ZA / 245



526 PZ / 245



527 ZA / 245

## Window handles



218L / 430



218L Q / 431



228 / 430



228 Q / 431



241 / 430



241 Q / 431



245 / 430



245 Q / 431

## Lifting-sliding door handles



203XXL / 460



218XXL / 461



224XXL / 460



245XXL / 461



**Design 215 Flush Line - HAFI Living space exclusive**

Maintenance-free door handle fitting with stainless steel base structure and spring pre-load, swivel-mounted, fast installation with the "Push-Click" function, also suitable for flush-mounted installation in the door panel, with rosettes and keyhole plate, invisible mounting.

tested and certified to DIN EN 1906 User Category Class 4

Classification key 47-B140B

Door thickness 38 to max. 70 mm

Stainless steel matte 
  Stainless steel polished 
  PVD

PZ 
 RZ 
 Euro

**Door handle fittings**

Illustration	Model	round rosette	Fire protection
		1-piece	
	215 / 870 / 871	•	•

**Knob-handle fittings**

Illustration	Model	round rosette	Fire protection
		1-piece	
	215 / 280 / 870	•	•
	215 / 285 / 870	•	•
	215 / 288 / 870	•	•

**Bathroom fittings**

Illustration	Model	round rosette	Fire protection
		1-piece	
	215 / 870 / 873 / 872	•	-



**Design 218L Flush Line - HAFI Living space exclusive**

Maintenance-free door handle fitting with stainless steel base structure and spring pre-load, swivel-mounted, fast installation with the "Push-Click" function, also suitable for flush-mounted installation in the door panel, with rosettes and keyhole plate, invisible mounting.

tested and certified to DIN EN 1906 User Category Class 4

Classification key 47-B140B

Door thickness 38 to max. 70 mm

Stainless steel matte 
  Stainless steel polished 
  PVD

PZ 
 RZ 
 Euro

**Door handle fittings**

Illustration	Model	round rosette	Fire protection
		1-piece	
	218L / 870 / 871	•	•

**Knob-handle fittings**

Illustration	Model	round rosette	Fire protection
		1-piece	
	218L / 280 / 870	•	•
	218L / 285 / 870	•	•
	218L / 288 / 870	•	•

**Bathroom fittings**

Illustration	Model	round rosette	Fire protection
		1-piece	
	218L / 870 / 873 / 872	•	-



**Design 218L Q Flush Line - HAFI Living space exclusive**

Maintenance-free door handle fitting with stainless steel base structure and spring pre-load, swivel-mounted, fast installation with the "Push-Click" function, also suitable for flush-mounted installation in the door panel, with rosettes and keyhole plate, invisible mounting.

tested and certified to DIN EN 1906 User Category Class 4

Classification key 47-B140B

Door thickness 38 to max. 70 mm

Stainless steel matte 
  Stainless steel polished 
  PVD

PZ 
 RZ 
 Euro

**Door handle fittings**

Illustration	Model	square rosette	Fire protection
		1-piece	
	218L Q / 880 / 881	•	•

**Knob-handle fittings**

Illustration	Model	square rosette	Fire protection
		1-piece	
	218L Q / 283 / 880	•	•
	218L Q / 288 / 880	•	•

**Bathroom fittings**

Illustration	Model	square rosette	Fire protection
		1-piece	
	218L Q / 880 / 883 / 882	•	-



**Design 228 Flush Line - HAFI Living space exclusive**

Maintenance-free door handle fitting with stainless steel base structure and spring pre-load, swivel-mounted, fast installation with the "Push-Click" function, also suitable for flush-mounted installation in the door panel, with rosettes and keyhole plate, invisible mounting.

tested and certified to DIN EN 1906 User Category Class 4

Classification key 47-B140B

Door thickness 38 to max. 70 mm

Stainless steel matte 
  Stainless steel polished 
  PVD

PZ 
 RZ 
 Euro

**Door handle fittings**

Illustration	Model	round rosette	Fire protection
		1-piece	
	228 / 870 / 871	•	•

**Knob-handle fittings**

Illustration	Model	round rosette	Fire protection
		1-piece	
	228 / 280 / 870	•	•
	228 / 285 / 870	•	•
	228 / 288 / 870	•	•

**Bathroom fittings**

Illustration	Model	round rosette	Fire protection
		1-piece	
	228 / 870 / 873 / 872	•	-





**Design 228 Q Flush Line - HAFI Living space exclusive**

Maintenance-free door handle fitting with stainless steel base structure and spring pre-load, swivel-mounted, fast installation with the "Push-Click" function, also suitable for flush-mounted installation in the door panel, with rosettes and keyhole plate, invisible mounting.

tested and certified to DIN EN 1906 User Category Class 4

Classification key 4|7|-|B|1|4|0|B

Door thickness 38 to max. 70 mm

Stainless steel matte 
  Stainless steel polished 
  PVD

PZ 
 RZ 
 Euro

**Door handle fittings**

Illustration	Model	square rosette	Fire protection
1-piece			
	228 Q / 880 / 881	•	•

**Knob-handle fittings**

Illustration	Model	square rosette	Fire protection
1-piece			
	228 Q / 283 / 880	•	•
	228 Q / 288 / 880	•	•

**Bathroom fittings**

Illustration	Model	square rosette	Fire protection
1-piece			
	228 Q / 880 / 883 / 882	•	-



**Design 241 Q Flush Line - HAFI Living space exclusive**

Maintenance-free door handle fitting with stainless steel base structure and spring pre-load, swivel-mounted, fast installation with the "Push-Click" function, also suitable for flush-mounted installation in the door panel, with rosettes and keyhole plate, invisible mounting.

tested and certified to DIN EN 1906 User Category Class 4

Classification key 4|7|-|B|1|4|0|B

Door thickness 38 to max. 70 mm

Stainless steel matte 
  Stainless steel polished 
  PVD

PZ 
 RZ 
 Euro

Design by Bastian Scholz

**Door handle fittings**

Illustration	Model	square rosette	Fire protection
1-piece			
	241 Q / 880 / 881	•	•

**Knob-handle fittings**

Illustration	Model	square rosette	Fire protection
1-piece			
	241 Q / 241K / 880	•	•
	241 Q / 242K / 880	•	•

**Bathroom fittings**

Illustration	Model	square rosette	Fire protection
1-piece			
	241 Q / 880 / 883 / 882	•	-



**Design 245 Flush Line - HAFI Living space exclusive**

Maintenance-free door handle fitting with stainless steel base structure and spring pre-load, swivel-mounted, fast installation with the "Push-Click" function, also suitable for flush-mounted installation in the door panel, with rosettes and keyhole plate, invisible mounting.

tested and certified to DIN EN 1906 User Category Class 4

Classification key 47-B140B

Door thickness 38 to max. 70 mm

Stainless steel matte 
  Stainless steel polished 
  PVD

PZ 
 RZ 
 Euro

**Door handle fittings**

Illustration	Model	round rosette	Fire protection
		1-piece	
	245 / 870 / 871	•	•

**Knob-handle fittings**

Illustration	Model	round rosette	Fire protection
		1-piece	
	245 / 280 / 870	•	•
	245 / 285 / 870	•	•
	245 / 288 / 870	•	•

**Bathroom fittings**

Illustration	Model	round rosette	Fire protection
		1-piece	
	245 / 870 / 873 / 872	•	-



**Design 245 Q Flush Line - HAFI Living space exclusive**

Maintenance-free door handle fitting with stainless steel base structure and spring pre-load, swivel-mounted, fast installation with the "Push-Click" function, also suitable for flush-mounted installation in the door panel, with rosettes and keyhole plate, invisible mounting.

tested and certified to DIN EN 1906 User Category Class 4

Classification key 47-B140B

Door thickness 38 to max. 70 mm

Stainless steel matte 
  Stainless steel polished 
  PVD

PZ 
 RZ 
 Euro

**Door handle fittings**

Illustration	Model	square rosette	Fire protection
		1-piece	
	245 Q / 880 / 881	•	•

**Knob-handle fittings**

Illustration	Model	square rosette	Fire protection
		1-piece	
	245 Q / 283 / 880	•	•
	245 Q / 288 / 880	•	•

**Bathroom fittings**

Illustration	Model	square rosette	Fire protection
		1-piece	
	245 Q / 880 / 883 / 882	•	-





Design by  
AIA Life Designers

**Design 247 Flush Line - HAFI Living space exclusive**

Maintenance-free door handle fitting with stainless steel base structure and spring pre-load, swivel-mounted, fast installation with the "Push-Click" function, also suitable for flush-mounted installation in the door panel, with rosettes and keyhole plate, invisible mounting.

tested and certified to DIN EN 1906 User Category Class 4

Classification key 47-B140B

Door thickness 38 to max. 70 mm

Stainless steel matte 
  Stainless steel polished 
  PVD

PZ 
 RZ 
 Euro

**Door handle fittings**

Illustration	Model	round rosette	Fire protection
		1-piece	
	247 / 870 / 871	•	•

**Knob-handle fittings**

Illustration	Model	round rosette	Fire protection
		1-piece	
	247 / 280 / 870	•	•
	247 / 285 / 870	•	•
	247 / 288 / 870	•	•

**Bathroom fittings**

Illustration	Model	round rosette	Fire protection
		1-piece	
	247 / 870 / 873 / 872	•	-



Design by  
Jean-Michel Wilmotte

**Design 248 Flush Line - HAFI Living space exclusive**

Maintenance-free door handle fitting with stainless steel base structure and spring pre-load, swivel-mounted, fast installation with the "Push-Click" function, also suitable for flush-mounted installation in the door panel, with rosettes and keyhole plate, invisible mounting.

tested and certified to DIN EN 1906 User Category Class 4

Classification key 47-B140B

Door thickness 38 to max. 70 mm

Stainless steel matte 
  Stainless steel polished 
  PVD

PZ 
 RZ 
 Euro

**Door handle fittings**

Illustration	Model	round rosette	Fire protection
		1-piece	
	248 / 870 / 871	•	•

**Knob-handle fittings**

Illustration	Model	round rosette	Fire protection
		1-piece	
	248 / 248K / 870	•	•

**Bathroom fittings**

Illustration	Model	round rosette	Fire protection
		1-piece	
	228 / 870 / 873 / 872	•	-



Design by  
STUDIO F-A-PORSCHÉ

**Design 311 Flush Line – HAFI Living space exclusive**

Maintenance-free door handle fitting with stainless steel base structure and spring pre-load, swivel-mounted, fast installation with the “Push-Click” function, also suitable for flush-mounted installation in the door panel, with rosettes and keyhole plate, invisible mounting.

tested and certified to DIN EN 1906 User Category Class 4

Classification key **47-B140B**

Door thickness 38 to max. 70 mm

Stainless steel glass-bead blast PVD

PZ RZ Euro

**Door handle fittings**

Illustration	Model	round rosette 1-piece	Fire protection
	311 / 870 / 871	•	•

**Knob-handle fittings**

Illustration	Model	square rosette 1-piece	Fire protection
	311 / 311K / 870	•	•

**Bathroom fittings**

Illustration	Model	square rosette 1-piece	Fire protection
	311 / 870 / 311WC	•	-



Design by  
STUDIO F-A-PORSCHÉ

**Design 212 Flush Line – HAFI Living space exclusive**

Maintenance-free door handle fitting with stainless steel base structure and spring pre-load, swivel-mounted, fast installation with the “Push-Click” function, also suitable for flush-mounted installation in the door panel, with rosettes and keyhole plate, invisible mounting.

tested and certified to DIN EN 1906 User Category Class 4

Classification key **47-B140B**

Door thickness 38 to max. 70 mm

Stainless steel glass-bead blast PVD

PZ RZ Euro

**Door handle fittings**

Illustration	Model	square rosette 1-piece	Fire protection
	212 Q / 880 / 881	•	•

**Knob-handle fittings**

Illustration	Model	square rosette 1-piece	Fire protection
	212 Q / 212K / 880	•	•

**Bathroom fittings**

Illustration	Model	square rosette 1-piece	Fire protection
	212 Q / 880 / 212WC	•	-







**Design 218L | 430 – HAFI Living space exclusive**

Window handles with 90° locking mechanism, cam Ø 10 mm, mounting points 43 mm, square pin 7 mm, free pin length from 24 mm protruding

- Stainless steel matte
- Stainless steel polished
- PVD



**Design 218L Q | 431 – HAFI Living space exclusive**

Window handles with 90° locking mechanism, cam Ø 10 mm, mounting points 43 mm, square pin 7 mm, free pin length from 24 mm protruding

- Stainless steel matte
- Stainless steel polished
- PVD



**Design 228 | 430 – HAFI Living space exclusive**

Window handles with 90° locking mechanism, cam Ø 10 mm, mounting points 43 mm, square pin 7 mm, free pin length from 24 mm protruding

- Stainless steel matte
- Stainless steel polished
- PVD



**Design 228 Q | 431 – HAFI Living space exclusive**

Window handles with 90° locking mechanism, cam Ø 10 mm, mounting points 43 mm, square pin 7 mm, free pin length from 24 mm protruding

- Stainless steel matte
- Stainless steel polished
- PVD



Design by  
Bastian Scholz

**Design 241 | 430 – HAFI Living space exclusive**

Window handles with 90° locking mechanism, cam Ø 10 mm, mounting points 43 mm, square pin 7 mm, free pin length from 24 mm protruding

- Stainless steel matte
- Stainless steel polished
- PVD



Design by  
Bastian Scholz

**Design 241 Q | 431 – HAFI Living space exclusive**

Window handles with 90° locking mechanism, cam Ø 10 mm, mounting points 43 mm, square pin 7 mm, free pin length from 24 mm protruding

- Stainless steel matte
- Stainless steel polished
- PVD



**Design 245 | 430 – HAFI Living space exclusive**

Window handles with 90° locking mechanism, cam Ø 10 mm, mounting points 43 mm, square pin 7 mm, free pin length from 24 mm protruding

- Stainless steel matte
- Stainless steel polished
- PVD



**Design 245 Q | 431 – HAFI Living space exclusive**

Window handles with 90° locking mechanism, cam Ø 10 mm, mounting points 43 mm, square pin 7 mm, free pin length from 24 mm protruding

- Stainless steel matte
- Stainless steel polished
- PVD



Design by  
Jean-Michel Wilmotte

**Design 248 | 430 – HAFI Living space exclusive**

Window handles with 90° locking mechanism, cam Ø 10 mm, mounting points 43 mm, square pin 7 mm, free pin length from 24 mm protruding

- Stainless steel matte
- Stainless steel polished
- PVD



Design by  
Jean-Michel Wilmotte

**Design 248T | 430 – HAFI Living space exclusive**

Window handles with 90° locking mechanism, cam Ø 10 mm, mounting points 43 mm, square pin 7 mm, free pin length from 24 mm protruding

- Stainless steel matte
- Stainless steel polished
- PVD



Design by  
STUDIO F·A·PORSCHE

**Design 311 | 430 – HAFI Living space exclusive**

Window handles with 90° locking mechanism, cam Ø 10 mm, mounting points 43 mm, square pin 7 mm, free pin length from 24 mm protruding

- Stainless steel glass-bead blast
- PVD





**Design 520 PZ | Handle 245 | Knob 280**



Protective fitting made from stainless steel, without spring system, invisible mounting, with knob and door handle.

Protection classes SK3 (ES2) and SK2 (ES1)

Square pin 8 mm, square pin 9 mm

PZ or ZA hole | 72 mm or 92 mm

■ Stainless steel matte ■ Stainless steel polished ● PVD

**Knob-handle fittings**

Illustration	Model	Protection class 2	Protection class 3	Fire protection <sup>Ⓛ</sup>
	280 / 245 / 520 PZ	37-0152U	47-0153U	•



**Design 521 ZA | Handle 245 | Knob 280**



Protective fitting made from stainless steel, without spring system, invisible mounting, with knob and door handle.

Protection classes SK3 (ES2) and SK2 (ES1)

Square pin 8 mm, square pin 9 mm

PZ or ZA hole | 72 mm or 92 mm

■ Stainless steel matte ■ Stainless steel polished ● PVD

**Knob-handle fittings**

Illustration	Model	Protection class 2	Protection class 3	Fire protection <sup>Ⓛ</sup>
	280 / 245 / 521 ZA	37-0152U	47-0153U	•

All available door handle and knob models – see page 68 to 69



**Design 524 PZ | Handle 245**



Protective fitting made from stainless steel, without spring system, invisible mounting, with knob and door handle.

Protection classes SK3 (ES2) and SK2 (ES1)

Square pin 8 mm, square pin 9 mm

PZ or ZA hole | 72 mm or 92 mm

■ Stainless steel matte ■ Stainless steel polished ● PVD

**Door handle fittings**

Illustration	Model	Protection class 2	Protection class 3	Fire protection <sup>Ⓛ</sup>
	245 / 245 / 524 PZ	37-0152U	47-0153U	•



**Design 525 ZA | Handle 245**



Protective fitting made from stainless steel, without spring system, invisible mounting, with knob and door handle.

Protection classes SK3 (ES2) and SK2 (ES1)

Square pin 8 mm, square pin 9 mm

PZ or ZA hole | 72 mm or 92 mm

■ Stainless steel matte ■ Stainless steel polished ● PVD

**Door handle fittings**

Illustration	Model	Protection class 2	Protection class 3	Fire protection <sup>Ⓛ</sup>
	245 / 245 / 525 ZA	37-0152U	47-0153U	•

All available door handle and knob models – see page 68 to 69



**Design 522 PZ | Handle 245 | Knob 283**



Protective fitting made from stainless steel, without spring system, invisible mounting, with knob and door handle.

Protection classes SK3 (ES2) and SK2 (ES1)

Square pin 8 mm, square pin 9 mm

PZ or ZA hole | 72 mm or 92 mm

■ Stainless steel matte ■ Stainless steel polished ● PVD

**Knob-handle fittings**

Illustration	Model	Protection class 2	Protection class 3	Fire protection
	283 / 245 / 522 PZ	37-0152U	47-0153U	•



**Design 523 ZA | Handle 245 | Knob 283**



Protective fitting made from stainless steel, without spring system, invisible mounting, with knob and door handle.

Protection classes SK3 (ES2) and SK2 (ES1)

Square pin 8 mm, square pin 9 mm

PZ or ZA hole | 72 mm or 92 mm

■ Stainless steel matte ■ Stainless steel polished ● PVD

**Knob-handle fittings**

Illustration	Model	Protection class 2	Protection class 3	Fire protection
	283 / 245 / 523 ZA	37-0152U	47-0153U	•

All available door handle and knob models – see page 68 to 69



**Design 526 PZ | Handle 245**



Protective fitting made from stainless steel, without spring system, invisible mounting, with knob and door handle.

Protection classes SK3 (ES2) and SK2 (ES1)

Square pin 8 mm, square pin 9 mm

PZ or ZA hole | 72 mm or 92 mm

■ Stainless steel matte ■ Stainless steel polished ● PVD

**Door handle fittings**

Illustration	Model	Protection class 2	Protection class 3	Fire protection
	202 / 245 / 526 PZ	37-0152U	47-0153U	•



**Design 527 ZA | Handle 245**



Protective fitting made from stainless steel, without spring system, invisible mounting, with knob and door handle.

Protection classes SK3 (ES2) and SK2 (ES1)

Square pin 8 mm, square pin 9 mm

PZ or ZA hole | 72 mm or 92 mm

■ Stainless steel matte ■ Stainless steel polished ● PVD

**Door handle fittings**

Illustration	Model	Protection class 2	Protection class 3	Fire protection
	202 / 245 / 527 ZA	37-0152U	47-0153U	•

All available door handle and knob models – see page 68 to 69



# Variations

## Knobs



242K / 520 PZ



248K / 520 PZ



263 / 520 PZ



280 / 520 PZ



285 / 520 PZ



286 / 520 PZ



288 / 520 PZ

## Door handles



201 / 524 PZ



202 / 524 PZ



203 / 524 PZ



207 / 524 PZ



209 / 524 PZ



218 / 524 PZ



224 / 524 PZ



225 / 524 PZ



226 / 524 PZ



227 / 524 PZ



228 / 524 PZ



234 / 524 PZ



245 / 524 PZ



247 / 524 PZ



248 / 524 PZ



253 / 524 PZ



490 PZ



491 ZA



**Design 203XXL / 460 / 461 HAFI Flush Line**

Lifting-sliding door handles, with 180° or alternative 90° locking mechanism, swivel-mounted, square pin 10 mm, with or without through cam and/or threaded cam and M5 screws, invisible mounting.

Stainless steel matte Stainless steel polished PVD



**Design 218XXL / 460 / 461 HAFI Flush Line**

Lifting-sliding door handles, with 180° or alternative 90° locking mechanism, swivel-mounted, square pin 10 mm, with or without through cam and/or threaded cam and M5 screws, invisible mounting.

Stainless steel matte Stainless steel polished PVD



**Design 224XXL / 460 / 461 HAFI Flush Line**

Lifting-sliding door handles, with 180° or alternative 90° locking mechanism, swivel-mounted, square pin 10 mm, with or without through cam and/or threaded cam and M5 screws, invisible mounting.

Stainless steel matte Stainless steel polished PVD



**Design 245XXL / 460 / 461 HAFI Flush Line**

Lifting-sliding door handles, with 180° or alternative 90° locking mechanism, swivel-mounted, square pin 10 mm, with or without through cam and/or threaded cam and M5 screws, invisible mounting.

Stainless steel matte Stainless steel polished PVD



# CONTACT

HAFI Beschläge GmbH  
Weissinger Straße 16  
D-89275 Elchingen

tel +49 (0) 7308 96 04 0  
fax +49 (0) 7308 96 04 15  
e-mail [info@hafi.de](mailto:info@hafi.de)

[www.hafi.de](http://www.hafi.de)